

The use or communication of the contents there of are forbidden without express authority. (당사의 사전 허락없이 무단 전제 및 복사를 금함)

NO	REVISION RECORD	DATE	CHK.	APPR.

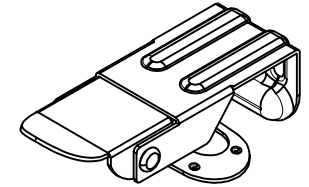

CCKC-01

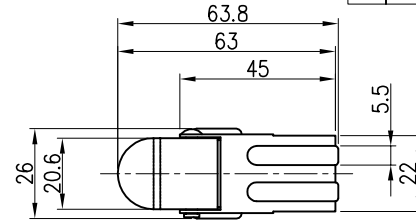
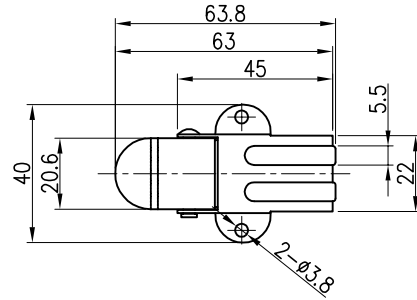
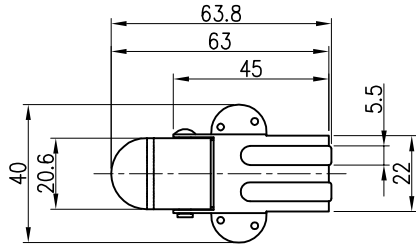
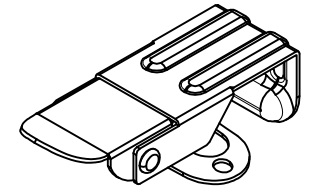
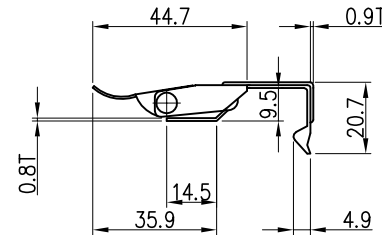
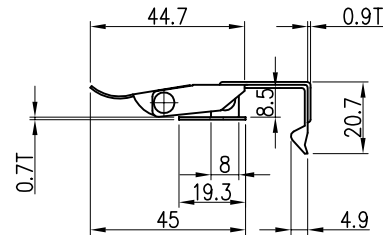
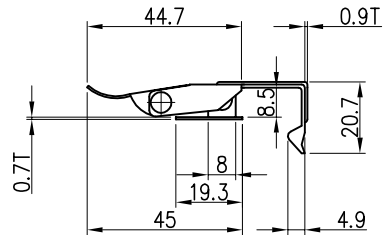

CCKC-02

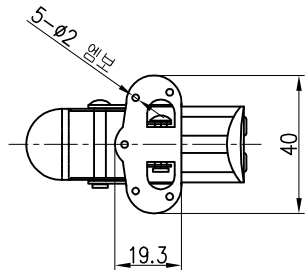

CCKC-01

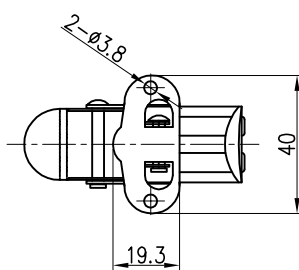

CCKC-02

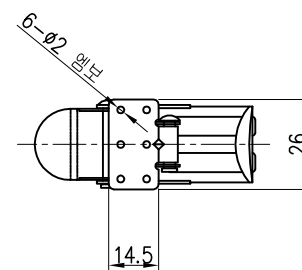

CCKC-03

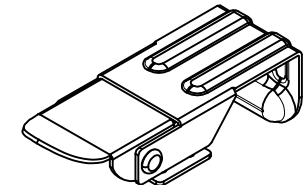

CCKC-03

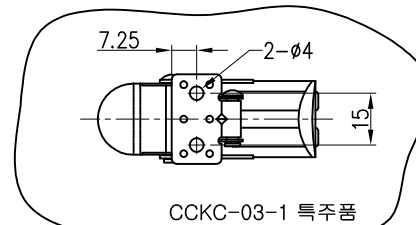

CCKC-03-1 특수품

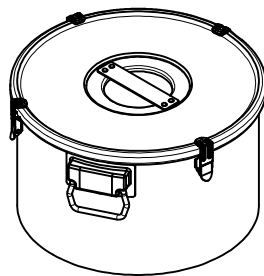

TOLERANCE(mm)
(KS B 0412에 준함)

6 이하	±0.05
6 ~ 30	±0.1
30 ~ 120	±0.15
120 ~ 315	±0.2
300 ~ 1000	±0.3
1000 ~ 2000	±0.5

FINISH	MATERIAL	UNIT	mm	NO.	DESCRIPTION	DWG. NO	QTY	REMARK
Barrel Polishing	SUS 304	APP.			DWG. NO.	-		V1.0
	t=0.7/0.8	DWG.	2021.03.01		PART NAME			
QTY				1/1	ASS'Y NAME	Catch		
1 EA/SET	Hardware			A3	MODEL NO.	CCKC		