

NO	REVISION RECORD	DATE	CHK.	APPR.

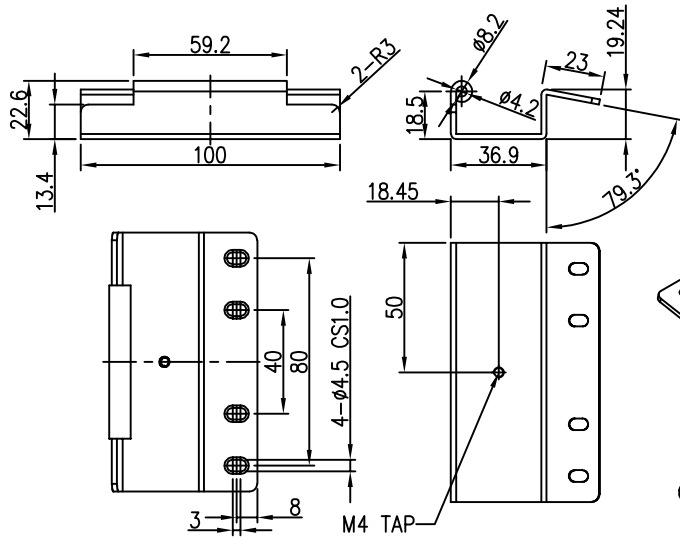

특주1

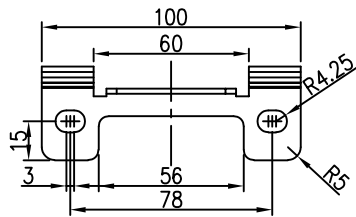

특주2

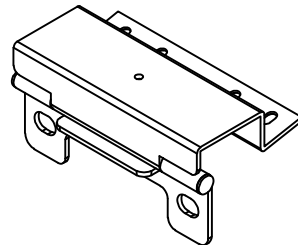
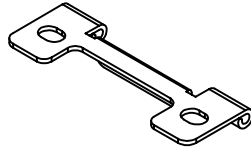
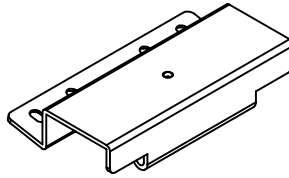
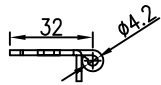
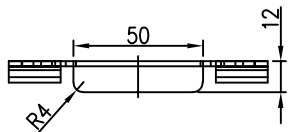

특주1+2 조립

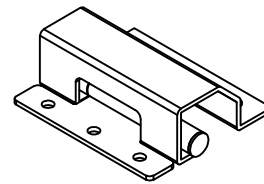
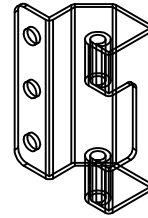

특주3+4 조립

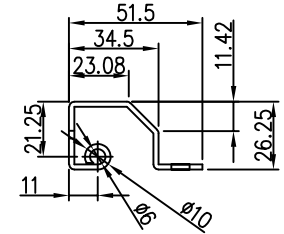
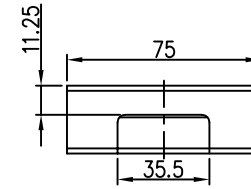

특주3

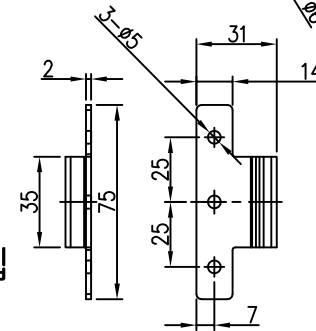
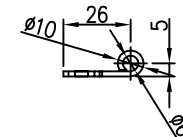
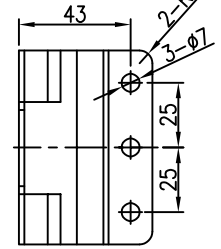

특주4

TOLERANCE(mm)
(KS B 0412에 준함)

6 이하	±0.05
6 ~ 30	±0.1
30 ~ 120	±0.15
120 ~ 315	±0.2
300 ~ 1000	±0.3
1000 ~ 2000	±0.5

Note

1. 재질 및 후처리: 고객 선택가능
2. 외관사양: 고객 선택 가능

FINISH	MATERIAL	UNIT	mm	NO.	DESCRIPTION	DWG. NO	QTY	REMARK
바일연마 (지장가능)	SUS/STEEL	APP.			DWG. NO.	-		V1.0
	-	DWG.	2023.11.30	<i>ML</i>	PART NAME			
QTY				1/1	ASS'Y NAME	철곡/커링 특수품 현지		
1 EA/SET	A Solution			A3	MODEL NO.	CH-특주품		