

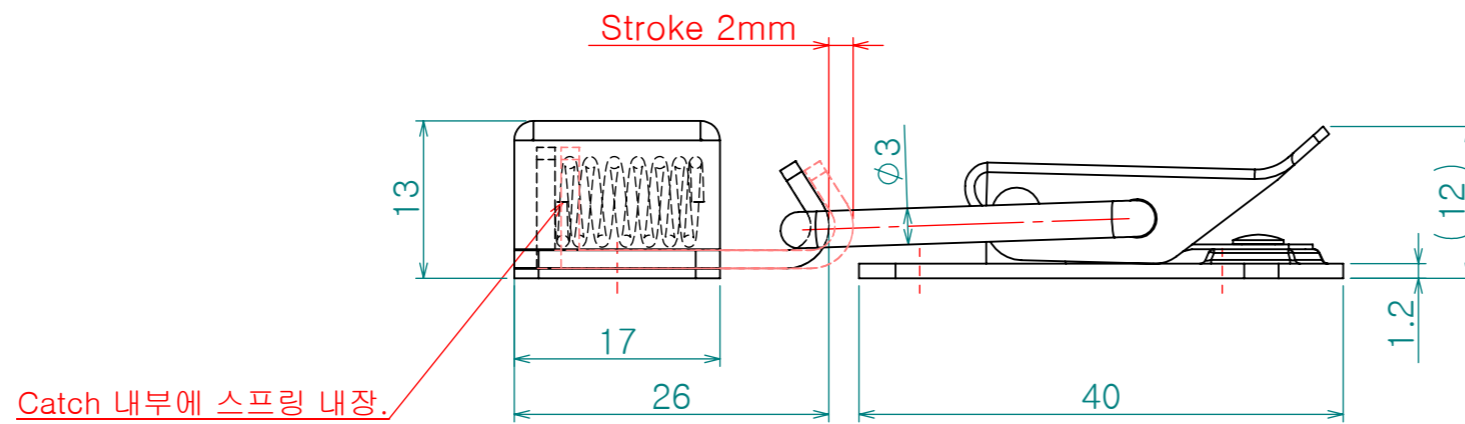

Re. No.	DESCRIPTION	DATE	DS.	CH.	AP.
△					
△					
△					

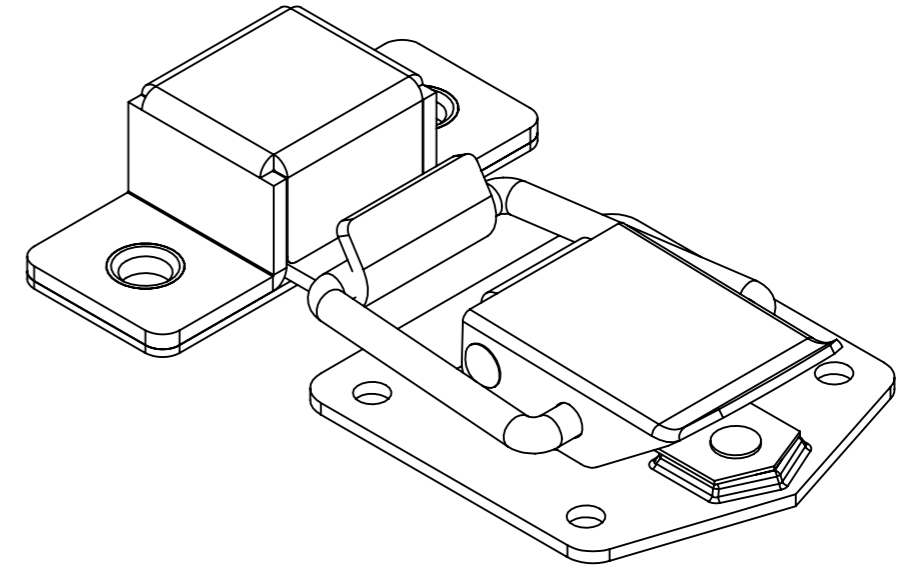
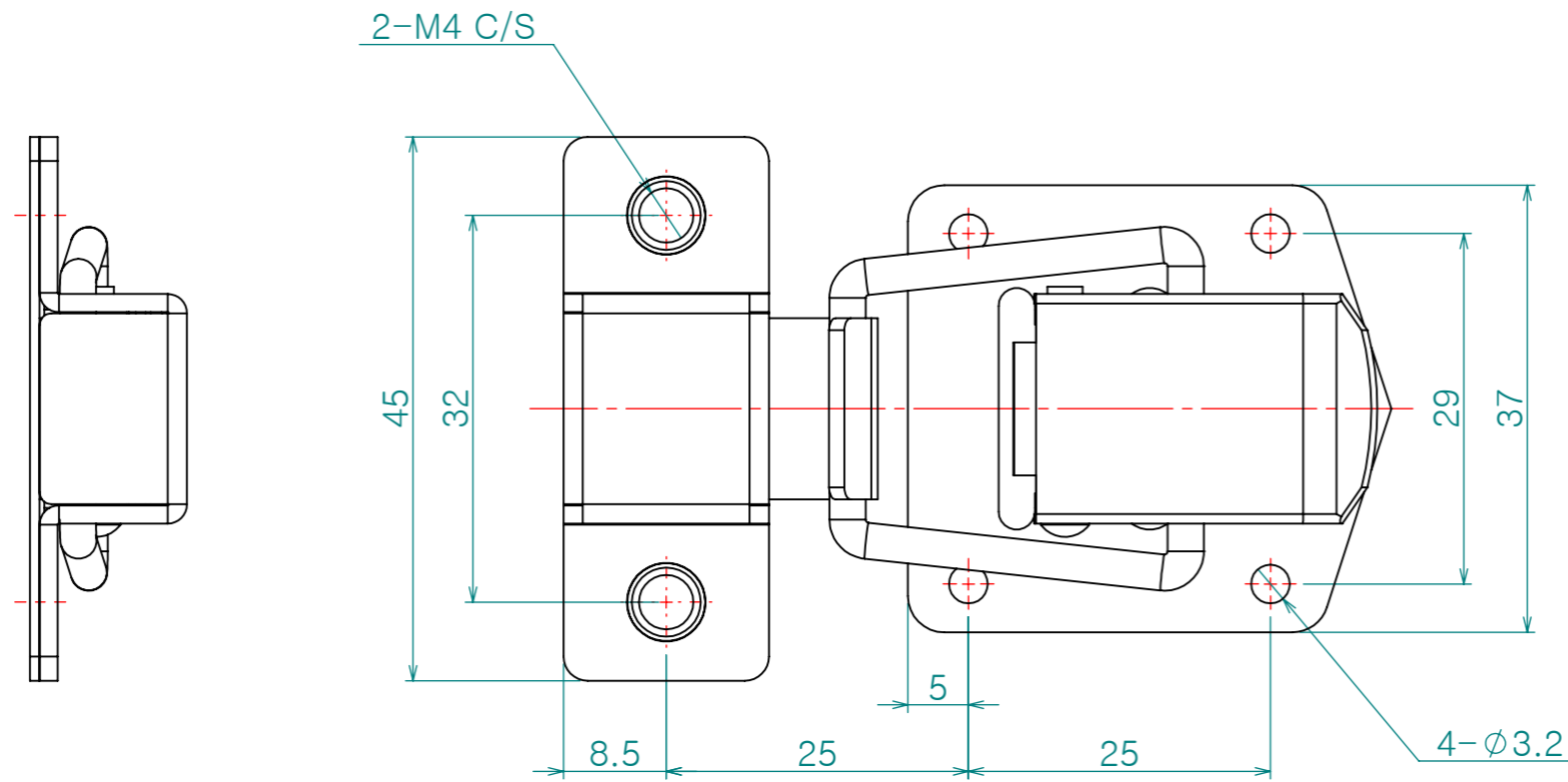

Note

- 1. 특징 :
- 2. 용도 :

Dimension (mm)	Precision	Material	Dwg. No.	QTY
0.5~3		STS304		**
3~6	±0.05	Finish	Part Name.	Weight
6~30	±0.1	바렐연마	**	-
30~120	±0.15	Revision	Ass'y Name	Scale
120~315	±0.2	-	**	1.6:1
315~1000	±0.3	Date	Model No.	
1000~2000	±0.5	2015-03-24	CC-1067	
KS B 0412에 준함		Designed by		
		Shin S H		
		Checked by	Approved by	