

Dwg. No.

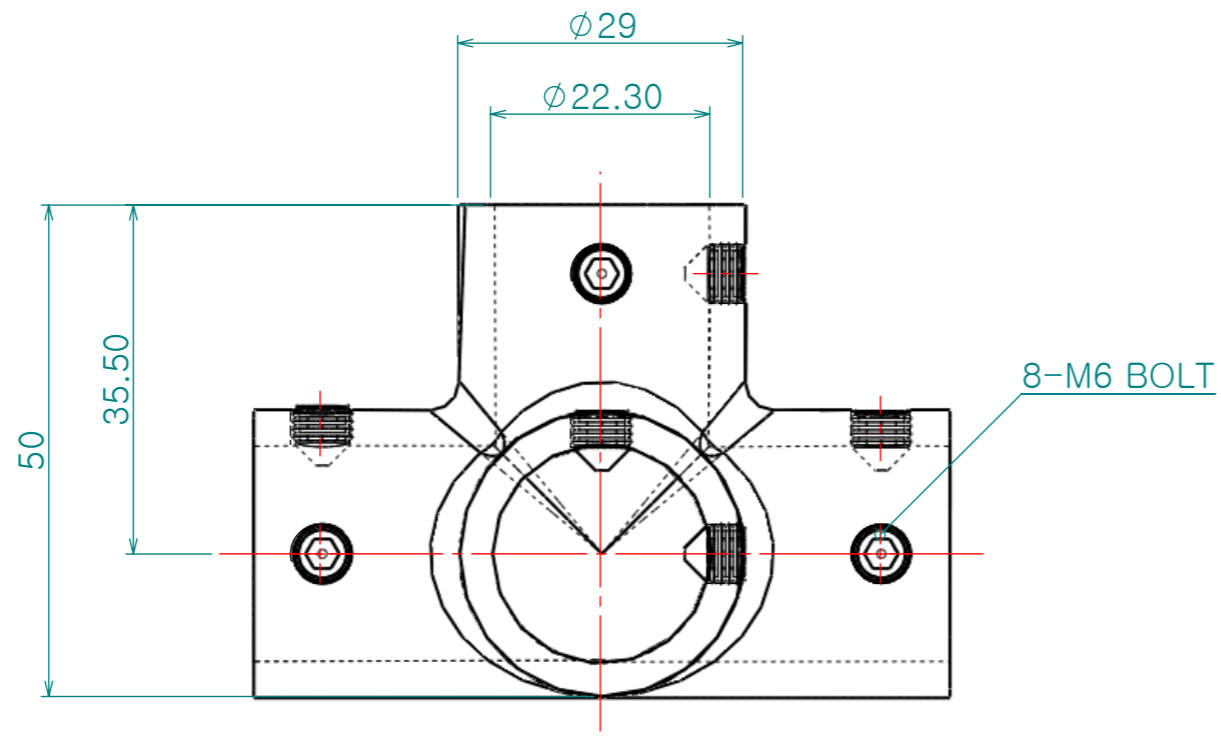

Re. No.	DESCRIPTION	DATE	DS.	CH.	AP.
△					
△					
△					

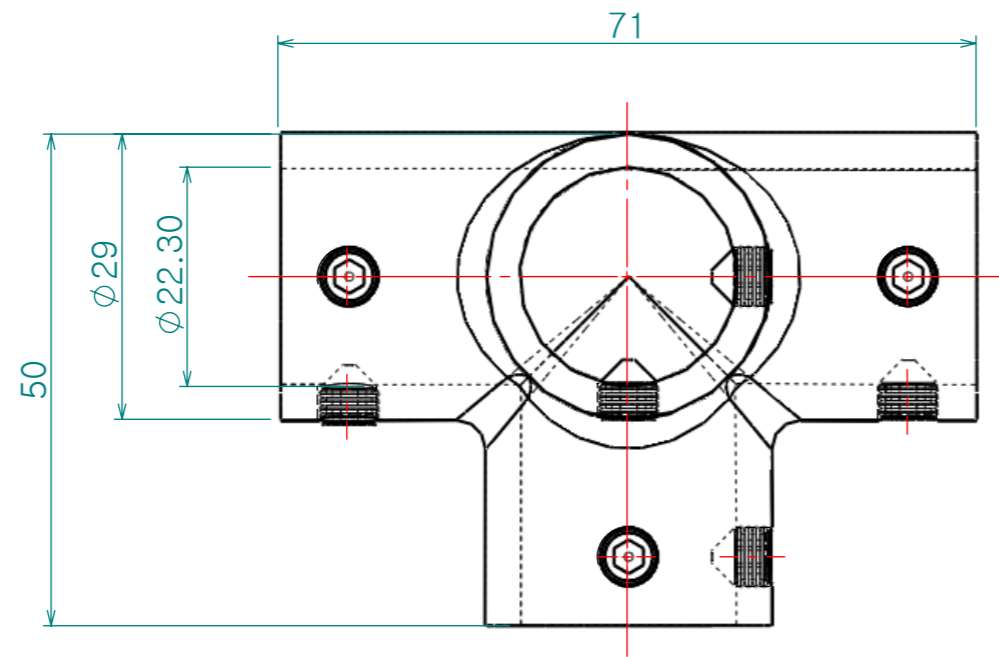
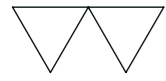
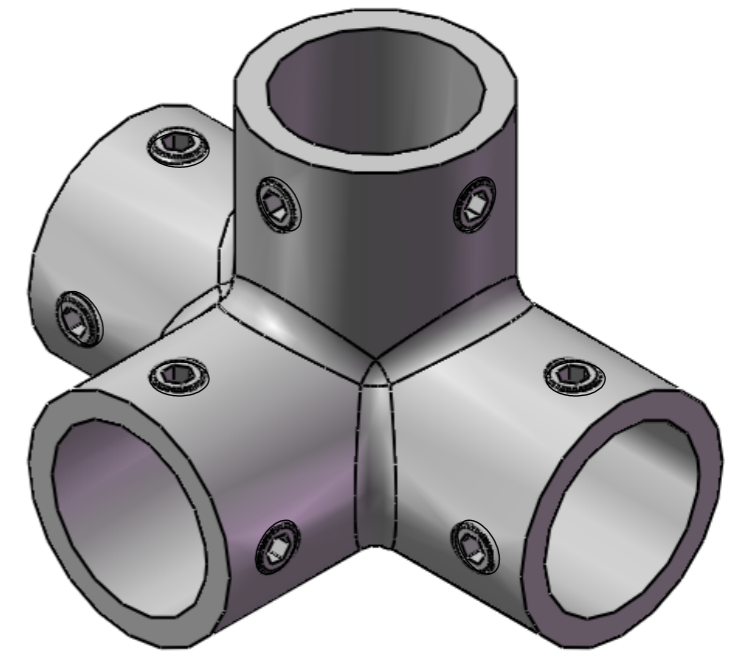

Note

- 1. 특징 :
- 2. 용도 :

Dimension (mm)	Precision	Material	Dwg. No.	QTY
0.5~3		STS316		*EA
3~6	±0.05	Finish	Part Name.	Weight
6~30	±0.1	광택연마	CM-D5183-01	-
30~120	±0.15	Revision	Ass'y Name	Scale
120~315	±0.2	-	**	1.3:1
315~1000	±0.3	Date	Model No.	
1000~2000	±0.5	2010-05-10	**	
KS B 0412에 준함		Designed by		
		Shin S H		
		Checked by		
		Approved by		